

# Iguana Visio



# Iguana Visio

## Dimensions

VISW\_Visio Wall

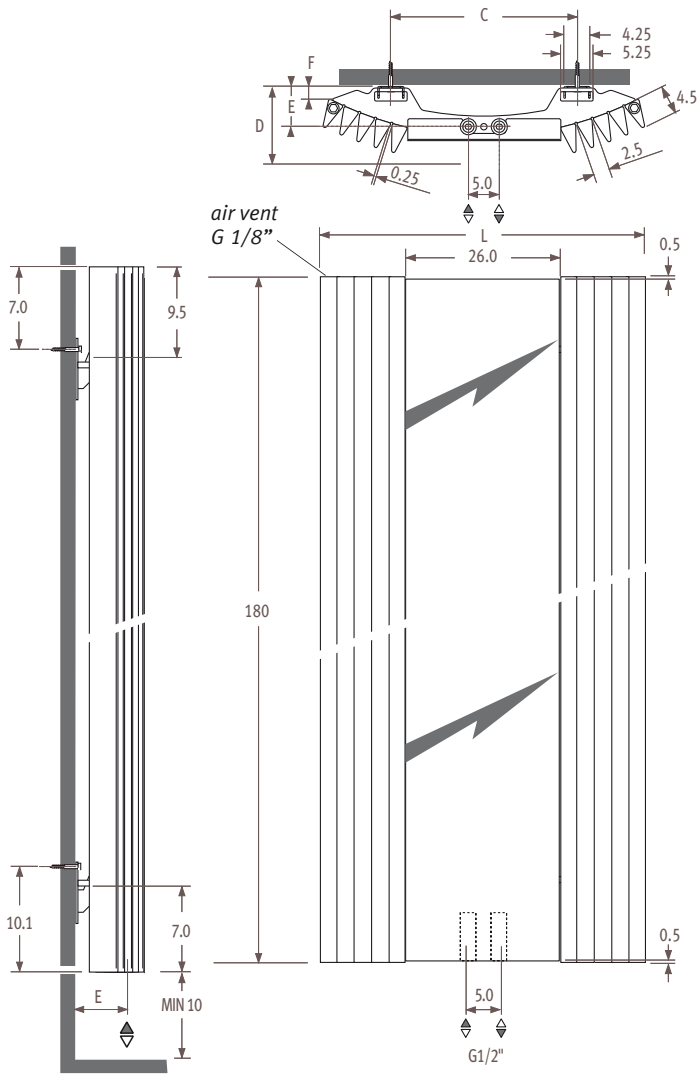

Dimensions in cm

|          |             |             |             |
|----------|-------------|-------------|-------------|
| <b>L</b> | <b>51.9</b> | <b>62.5</b> | <b>73.3</b> |
| <b>C</b> | 30.0        | 40.0        | 50.0        |
| <b>D</b> | 10.7        | 11.2        | 12.7        |
| <b>E</b> | 6.7         | 6.2         | 7.7         |
| <b>F</b> | 2.2         | 3.0         | 2.5         |

## Connections

### Two pipe

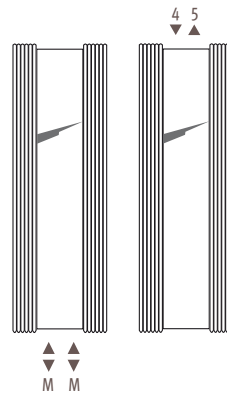

### Standard connection

Code MM

### Top end connection

Code 45 or 54

(1° number > flow)

When ordering a top end connection, no insert pipe should be ordered. Air vents should be positioned on the central heating pipes.

Ordering code: specify code 45 or 54 instead if MM, no surcharge.

### Notice

To guarantee the output of the Iguana models and to limit the pressure drop, Jaga recommends the use of tube diameter 16/2, 18/1 or 18/2.

## Dimensions options

### Large shelf

| Visio    | 29 | 41   | 51   | 62   | 73   | 83   |
|----------|----|------|------|------|------|------|
| <b>L</b> | -  | 53.0 | 53.0 | 54.0 | 54.0 | 54.0 |
| <b>D</b> | -  | 28.9 | 30.5 | 30.0 | 31.5 | 33.5 |

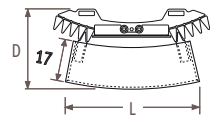

### Small shelf

| Visio    | 29 | 41   | 51   | 62   | 73   | 83   |
|----------|----|------|------|------|------|------|
| <b>L</b> | -  | 48.0 | 48.0 | 51.0 | 51.0 | 51.0 |
| <b>D</b> | -  | 21.9 | 23.5 | 23.0 | 24.5 | 26.5 |

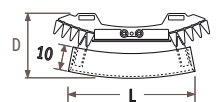

### Towel rail

| Visio    | 29 | 41   | 51   | 62   | 73   | 83   |
|----------|----|------|------|------|------|------|
| <b>L</b> | -  | 55.0 | 55.0 | 66.0 | 66.0 | 66.0 |
| <b>D</b> | -  | 18.8 | 20.4 | 19.9 | 21.4 | 23.4 |

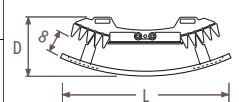

### Hat rack

| Visio    | 29 | 41   | 51   | 62   | 73   | 83   |
|----------|----|------|------|------|------|------|
| <b>L</b> | -  | 55.0 | 55.0 | 66.0 | 66.0 | 66.0 |
| <b>D</b> | -  | 18.8 | 20.4 | 19.9 | 21.4 | 23.4 |

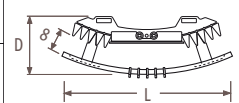

## Prices & outputs

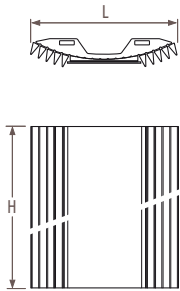

### Standard delivery:

- Visio with central connection MM underneath
- wall fixing
- 2 chrome-plated air vents G 1/8"

### Standard colours:

- sandblast grey metallic 001
- white 301(RAL 9010 satin)
- white 333(RAL 9016 satin)

## Iguana VISW

code height length colour conn.  
ORDERING CODE: VISW. 180 051. XXX /MM

| H   | L 051        | 062    | 073           |
|-----|--------------|--------|---------------|
| 180 | 75/65/20     | 719    | 1007 1294     |
|     | 55/45/20     | 361    | 506 650       |
|     | st. colour £ | 411.40 | 491.20 564.00 |
|     | other £      | 473.10 | 564.90 648.60 |
| 200 | 75/65/20     | 751    | 1051 1352     |
|     | 55/45/20     | 379    | 530 682       |
|     | st. colour £ | 436.60 | 522.60 600.90 |
|     | other £      | 502.00 | 601.00 691.00 |
| 220 | 75/65/20     | 780    | 1092 1404     |
|     | 55/45/20     | 395    | 552 710       |
|     | st. colour £ | 461.70 | 553.90 637.90 |
|     | other £      | 531.00 | 637.00 733.60 |

## Options

### Large shelf in beech veneer

| CODE        | For Visio | L  | £      |
|-------------|-----------|----|--------|
| 9087.020529 | L 51      | 53 | 145.00 |
| 9087.020543 | L 62-73   | 54 | 145.00 |



### Small shelf in beech veneer

| CODE        | For Visio | L  | £      |
|-------------|-----------|----|--------|
| 9087.021480 | L 51      | 48 | 145.00 |
| 9087.021512 | L 62-73   | 51 | 145.00 |



### Towel rail chrome-plated aluminium

| CODE        | For Visio | L  | £      |
|-------------|-----------|----|--------|
| 9087.023550 | L 51      | 55 | 125.90 |
| 9087.023656 | L 62-73   | 66 | 125.90 |



### Hat rack chrome-plated aluminium

| CODE        | For Visio | L  | £      |
|-------------|-----------|----|--------|
| 9087.024550 | L 51      | 55 | 145.00 |
| 9087.024656 | L 62-73   | 66 | 145.00 |



Output measured in accordance with EN442, at a water temperature of 75/65 and a room temperature of 20°C ( $\Delta T=50$ ).